

High-Speed Balanced Photoreceiver

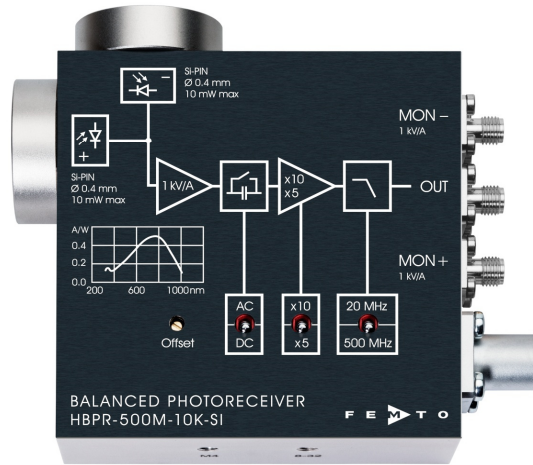

Features

- **Bandwidth DC to 500 MHz**
- **Common-Mode Rejection Ratio (CMRR) 40 dB typ.**
- **Si-PIN detectors, 0.4 mm active diameter**
- **Spectral range 320 – 1000 nm**
- **Very low NEP, down to 12 pW/√Hz**
- **Transimpedance gain switchable 5×10^3 V/A, 10×10^3 V/A**
- **High dynamic input range up to 2×10 mW balanced optical power**
- **Fast monitor outputs with 10 MHz bandwidth and 1×10^3 V/A gain**
- **Switchable low pass filter for minimizing wideband noise**
- **Free-space input 1.035"-40 threaded, easily convertible to fiber optic input (FC and FSMA) with optionally available screw-on adapters**
- **UNC 8-32 and M4 tapped holes for mounting on standard posts with metric and imperial thread**

Applications

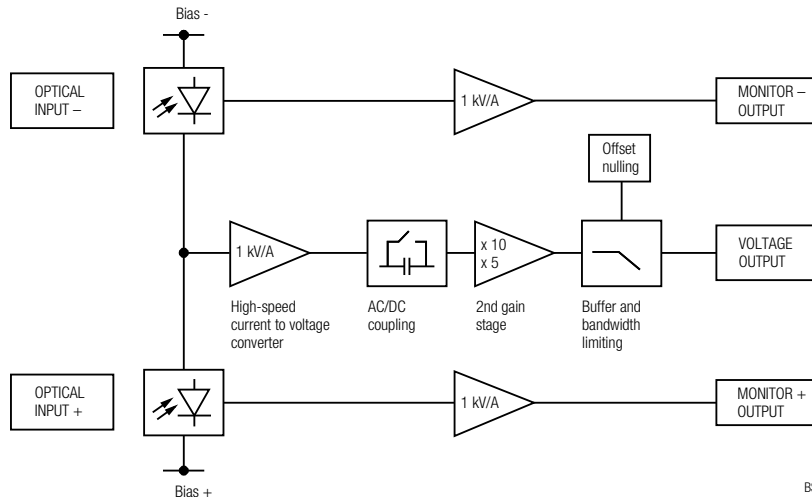

- **Spectroscopy**
- **Heterodyne detection**
- **Optical coherence tomography (OCT)**
- **Optical delay measurement**
- **Differential optical front-end for oscilloscopes, spectrum analyzers, A/D converters and RF lock-in amplifiers**

Block Diagram







BS-HBPR_R2

High-Speed Balanced Photoreceiver

<p>Intended Use</p>	<p>The HBPR-500M-10K-SI-FST photoreceiver consists of a combination of two anti-parallel connected photodiodes with a subsequent low-noise transimpedance amplifier. It is designed for fast conversion of the tiny difference of two optical signals into an equivalent output voltage. Operation is mostly self-explanatory. If in doubt, consult this document or contact support@femto.de.</p> <p>For safe operation, please refer to the damage thresholds specified in the "Absolute Maximum Ratings", "Temperature Range" and "Power Supply" sections of this document.</p> <p>The operating environment must be free of smoke, dust, grease, oil, condensing moisture, and other contaminants that could affect the operation or performance.</p>
<p>Application Notes</p>	<p>The damage threshold of 12 mW for each photodiode mentioned in the "Absolute Maximum Ratings" section applies to reasonably homogeneous illumination of the photodiodes. Extreme focusing of the light beam can lead to damage to the photodiodes, even at significantly lower light power.</p> <p>To achieve optimum performance, it is recommended that the CW light intensity at both inputs be well balanced. The monitor outputs can be used for continuous balance control. For setups with arbitrarily varying CW offset, the photoreceiver's AC mode can be helpful. Using AC mode increases the CW offset range to 2.5 mW (@ 760 nm), regardless of the gain setting.</p>
<p>Available Version</p>	<p>HBPR-500M-10K-SI-FST</p>  <p>1.035"-40 threaded flanges with internally threaded coupler rings mounted (outer dia. 30 mm), for free space applications, compatible with many optical standard accessories</p> <p>Optional: fiber adapters PRA-FC, PRA-FCA, PRA-FSMA</p> 
<p>Related Models</p> <p>Si Versions</p>	<p>Various free space or fiber coupled HBPR models, with bandwidth up to 500 MHz, in the spectral range from 320 nm to 1700 nm are available.</p> <p>Fiber-coupled with fix/permanent FC fiber connectors</p> <p>HBPR-100M-60K-SI-FC Si-PIN \varnothing 0.8 mm, DC – 100 MHz, 320 – 1000 nm, CMRR 50 dB, gain $2.0 \times 10^4 / 6.0 \times 10^4$ V/A switchable</p> <p>HBPR-200M-30K-SI-FC Si-PIN \varnothing 0.8 mm, DC – 200 MHz, 320 – 1000 nm, CMRR 45 dB, gain $1.0 \times 10^4 / 3.0 \times 10^4$ V/A switchable</p> <p>HBPR-500M-10K-SI-FC Si-PIN \varnothing 0.4 mm, DC – 500 MHz, 320 – 1000 nm, CMRR 40 dB, gain $5.0 \times 10^3 / 10.0 \times 10^3$ V/A switchable</p> <p>Free space versions with 1.035"-40 threaded flanges</p> <p>HBPR-100M-60K-SI-FST Si-PIN \varnothing 0.8 mm, DC – 100 MHz, 320 – 1000 nm, CMRR 50 dB, gain $2.0 \times 10^4 / 6.0 \times 10^4$ V/A switchable</p> <p>HBPR-200M-30K-SI-FST Si-PIN \varnothing 0.8 mm, DC – 200 MHz, 320 – 1000 nm, CMRR 45 dB, gain $1.0 \times 10^4 / 3.0 \times 10^4$ V/A switchable</p>

High-Speed Balanced Photoreceiver

<p>Related Models (continued)</p> <p>InGaAs Versions</p>	<p>Fiber-coupled with fix/permanent FC fiber connectors (ball lense coupled)</p> <p>HBPR-100M-60K-IN-FC InGaAs-PIN \varnothing 0.08 mm, DC – 100 MHz, 900 – 1700 nm, CMRR 55 dB, gain $2.0 \times 10^4 / 6.0 \times 10^4$ V/A switchable</p> <p>HBPR-200M-30K-IN-FC InGaAs-PIN \varnothing 0.08 mm, DC – 200 MHz, 900 – 1700 nm, CMRR 50 dB, gain $1.0 \times 10^4 / 3.0 \times 10^4$ V/A switchable</p> <p>HBPR-500M-10K-IN-FC InGaAs-PIN \varnothing 0.08 mm, DC – 500 MHz, 900 – 1700 nm, CMRR 45 dB, gain $5.0 \times 10^3 / 10.0 \times 10^3$ V/A switchable</p> <p>Free space versions with 1.035"-40 threaded flanges</p> <p>HBPR-100M-60K-IN-FST InGaAs-PIN \varnothing 0.3 mm, DC – 100 MHz, 800 – 1700 nm, CMRR 50 dB, gain $2.0 \times 10^4 / 6.0 \times 10^4$ V/A switchable</p> <p>HBPR-200M-30K-IN-FST InGaAs-PIN \varnothing 0.3 mm, DC – 200 MHz, 800 – 1700 nm, CMRR 45 dB, gain $1.0 \times 10^4 / 3.0 \times 10^4$ V/A switchable</p> <p>HBPR-450M-10K-IN-FST InGaAs-PIN \varnothing 0.3 mm, DC – 450 MHz, 800 – 1700 nm, CMRR 35 dB, gain $5.0 \times 10^3 / 10.0 \times 10^3$ V/A switchable</p>
<p>Available Accessories</p>	<p>PRA-FC  PRA-FCA  PRA-FSMA  Fiber-adaptor with external 1.035"-40 thread</p> <p>PS-15-25-L  Power Supply Input: 100 – 240 VAC Output: ± 15 VDC</p>
<p>Specifications</p>	<p>Test conditions $V_s = \pm 15$ V, $T_A = 25$ °C, output load impedance 50 Ω, warm-up 20 minutes (min. 10 minutes recommended), monitor outputs terminated with 1 MΩ</p> <p>Gain</p> <p>Transimpedance gain 5×10^3 V/A (@ 2nd gain $\times 5$, 50 Ω load) 10×10^3 V/A (@ 2nd gain $\times 10$, 50 Ω load)</p> <p>Gain accuracy ± 1 % electrical</p> <p>Conversion gain 2.55×10^3 V/W typ. (@ 2nd gain $\times 5$, 760 nm, 50 Ω load) 5.1×10^3 V/W typ. (@ 2nd gain $\times 10$, 760 nm, 50 Ω load)</p> <p>Common mode rejection ratio (CMRR) 50 dB typ. ($f \leq 100$ MHz) 40 dB typ. ($f \leq 500$ MHz)</p> <p>Frequency Response</p> <p>Lower cut-off frequency DC / 10 Hz, switchable</p> <p>Upper cut-off frequency (-3 dB) 500 MHz (@ 2nd gain $\times 5$), 460 MHz (@ 2nd gain $\times 10$), switchable to 20 MHz</p> <p>Time Response</p> <p>Rise/fall time (10 % – 90 %) 0.85 ns (@ 2nd gain $\times 5$); 0.95 ns (@ 2nd gain $\times 10$) 17.5 ns (@ bandwidth set to 20 MHz)</p>

High-Speed Balanced Photoreceiver

Specifications (continued)			
Input	Noise equivalent power (NEP)	minimum 12 pW/√Hz (@ 760 nm) 13 pW/√Hz (@ 760 nm, 20 MHz) 29 pW/√Hz (@ 760 nm, 200 MHz) 60 pW/√Hz (@ 760 nm, 500 MHz)	
	Maximum differential CW power (for linear amplification)	400 μW (@ 2 nd gain ×5, DC-coupled, 760 nm) 200 μW (@ 2 nd gain ×10, DC-coupled, 760 nm) 2.5 mW (@ AC-coupled, 760 nm)	
	Max. optical CW balanced power (common mode power)	10 mW (on each photodiode, @ 760 nm)	
	Monitor optical saturation power (limited by maximum ratings)	12 mW (@ 760 nm)	
	Detector	Detector type	Si-PIN photodiode
	Active area	∅ 400 μm	
	Spectral range	320 – 1000 nm	
	Sensitivity	0.51 A/W typ. (@ 760 nm)	
Output	Output voltage range	±1.0 V (@ 50 Ω load) for linear operation and low harmonic distortion	
	Max. output voltage	±2.0 V (@ 50 Ω load)	
	Offset voltage compensation	±100 mV typ., adjustable by offset potentiometer	
	Output impedance	50 Ω (terminate with 50 Ω load)	
	Slew rate	2800 V/μs	
	Max. output current	70 mA	
	Output reflection S22	-30 dB @ < 100 MHz -20 dB @ < 800 MHz	
	Output noise (typ.)	2.5 mV RMS (16 mV peak-peak) (@ 2 nd gain ×5) 4.1 mV RMS (27 mV peak-peak) (@ 2 nd gain ×10) 0.25 mV RMS (1.7 mV peak-peak) (@ 2 nd gain ×5, BW 20 MHz) 0.4 mV RMS (2.5 mV peak-peak) (@ 2 nd gain ×10, BW 20 MHz) (@ 50 Ω load, no signal on detectors, measurement bandwidth 2 GHz)	
	Monitor Outputs	Gain	1 × 10 ³ V/A (@ ≥ 100 kΩ load)
		Voltage range	0 ... +10 V (@ ≥ 100 kΩ load)
	Output impedance	50 Ω (terminate with ≥ 100 kΩ load)	
	Max. output current	30 mA typ.	
	Bandwidth	DC – 10 MHz	
	Output noise	0.6 mV RMS (4 mV peak-peak) (@ 100 kΩ load, no signal on detectors, measurement bandwidth 200 MHz)	
Power Supply	Supply voltage	±15 V (±14.5 V ... ±16.5 V)	
	Supply current	-90 / +120 mA typ. (depends on operating conditions, recommended power supply capability min. ±200 mA)	
Optical Input Connector	Material FST flange	1.4305 stainless steel, nickel-plated	
	Material FST coupler ring	1.4305 stainless steel, glass bead blasted	
Case	Weight	410 g (0.9 lbs) including coupler rings	
	Material	AlMg3Mn, nickel-plated	
Temperature Range	Storage temperature	-40 °C ... +85 °C	
	Operating temperature	0 °C ... +60 °C	

Absolute Maximum Ratings	Optical input power (CW)	12 mW (on each photodiode)
	Power supply voltage	±20 V

High-Speed Balanced Photoreceiver

Connectors

Inputs

1.035"-40 threaded flanges for free space applications and for use with various types of optical standard accessories

Outputs

SMA jacks (female)

Power supply

LEMO® series 1S, 3-pin fixed socket (mating plug type: FFA.1S.303.CLAC52)

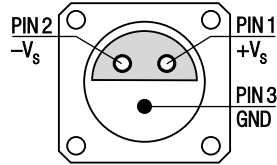

Pin 1: +15 V
Pin 2: -15 V
Pin 3: GND

Scope of Delivery

HBPR-500M-10K-SI-FST, 2 × threaded coupler ring, Lemo® 3-pin connector, 3 × adapter SMA (male) to BNC (female), datasheet

Ordering Information

HBPR-500M-10K-SI-FST 1.035"-40 threaded flanges for free space applications and for use with various types of optical standard accessories

Spectral Response

HBPR-500M-10K-SI-FST (FC fiber optic input)

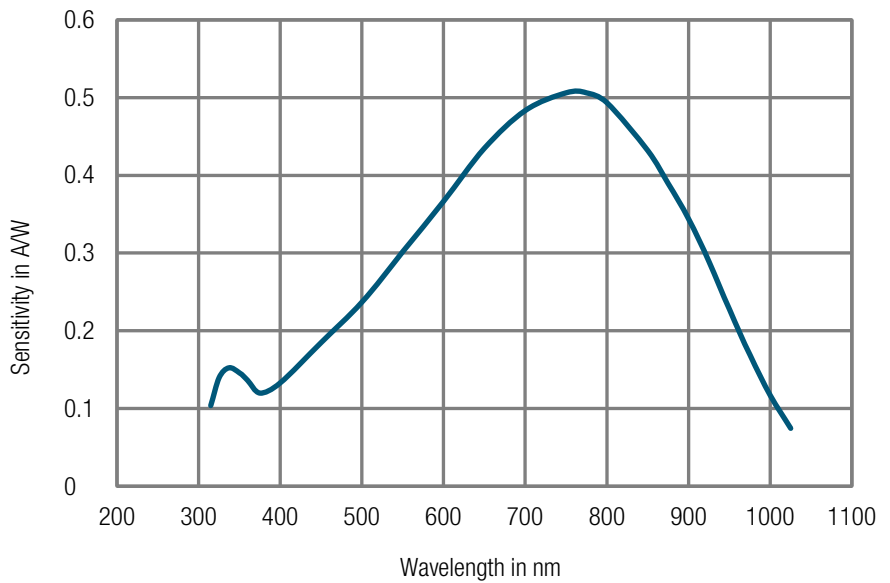

DB-Sens-HBPR-500-SI_R2

High-Speed Balanced Photoreceiver

Dimensions

HBPR-500M-10K-SI-FST

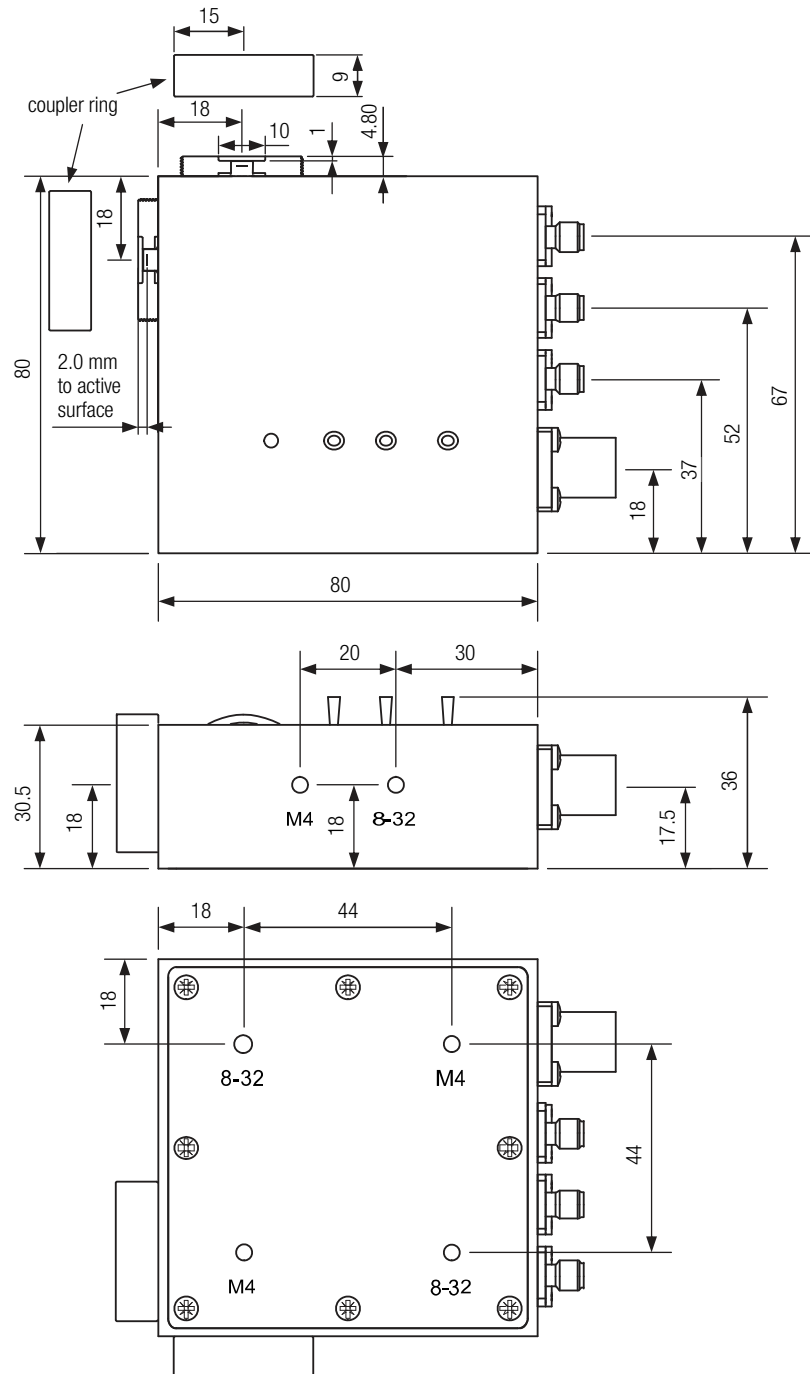

DZ-HBPR_FST_R2

The bottom plate may be rotated to match the appropriate mounting thread to the optical axis by unscrewing the 8 screws.

FEMTO Messtechnik GmbH
 Klosterstr. 64
 10179 Berlin · Germany
 Phone: +49 30 280 4711-0
 Fax: +49 30 280 4711-11
 Email: info@femto.de
 www.femto.de

Specifications are subject to change without notice. Information provided herein is believed to be accurate and reliable. However, no responsibility is assumed by FEMTO Messtechnik GmbH for its use, nor for any infringement of patents or other rights of third parties which may result from its use. No license is granted by implication or otherwise under any patent or patent rights of FEMTO Messtechnik GmbH. Product names mentioned may also be trademarks used here for identification purposes only.

© by FEMTO Messtechnik GmbH · Printed in Germany